

Design Analysis of Hybrid-PM Synchronous Generator for Wind Applications

L. L. Amuhaya and M. J. Kamper.



UNIVERSITEIT•STELLENBOSCH•UNIVERSITY
jou kennisvennoot • your knowledge partner

Domestic Use of Energy, Cape town

30 - 01 April 2015



Outline

- Introduction
- Classification
- Mechanical Considerations
- Analytical Analysis
- FEM Analysis
- Conclusion

Introduction

Grid compliance requirement¹

- Power factor, voltage and reactive power control of the generator
- $\pm 10\%$ variable flux

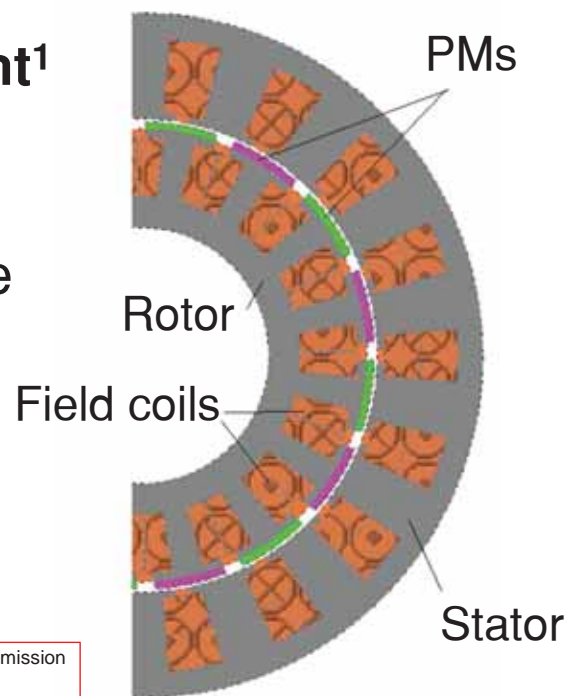

1. "Grid code requirements for wind energy facilities connected to distribution or transmission systems in South Africa," The RSA Grid Code Secretariat, Version 5.4, July, 2012.

Classification of Hybrid-PMSG

1. Location of PMs and copper excitation (rotor or stator)
2. Connection of excitation sources (series hybrid excited/ parallel hybrid excited).

Special Features

- Two excitation sources
- Bi directional DC current
- PMs and excitation coils placement

Applications

- as a generator it may be used in wind application and island operation eg ship
- as a motor in vehicular technology

Mechanical Considerations

Radial flux construction versus axial flux²:

- Rotor is easily cooled, can be more rugged, and the dimensions easily modified to produce required torque.
- No axial forces.

[2] K. Kamiev, J. Nerg, J. Pyrhonen, J. Tapia “Feasibility of Different Excitation Methods of Synchronous Generators in Island Operation” ICEM, Marseille France 2012.

Analytical Analysis

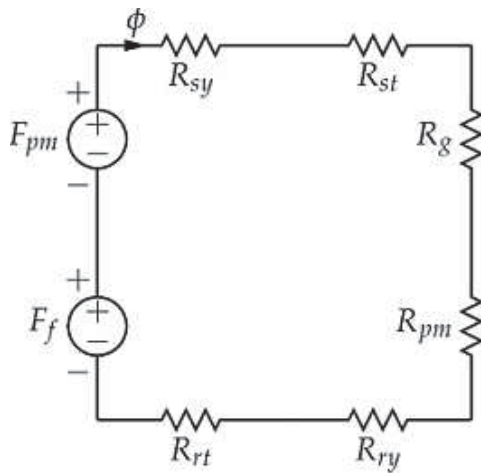

MEC for a series hybrid-PMSG.

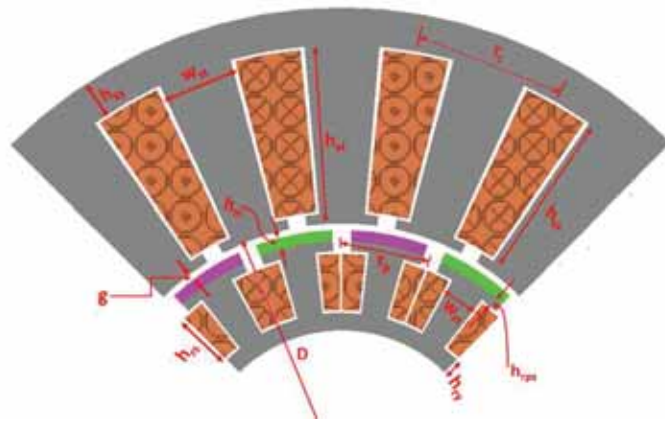

Cross-section of hybrid-PMSG.

$$F_f + F_{pm} = F_K + F_m.$$

Analytical Analysis cont...

A variable flux factor defined from the MMF supplied by each of the sources is

$$C_{hf} = \frac{F_f}{F_f + F_{pm}}$$

F_f is the MMF from the field coils and F_{pm} is from the PM.

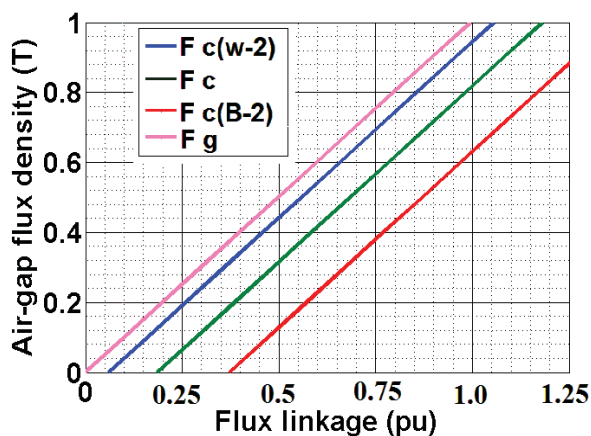

Bg versus flux linkage

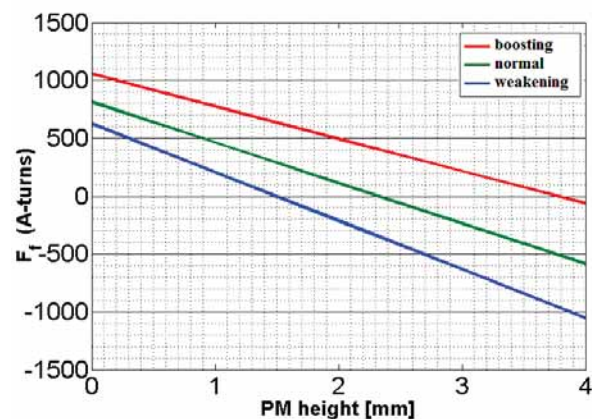

MMF versus PM height

Analytical Analysis *cont...*

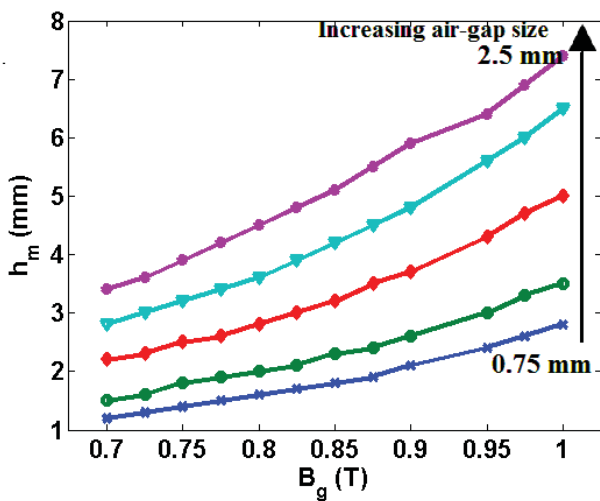

Height of PM versus B_g

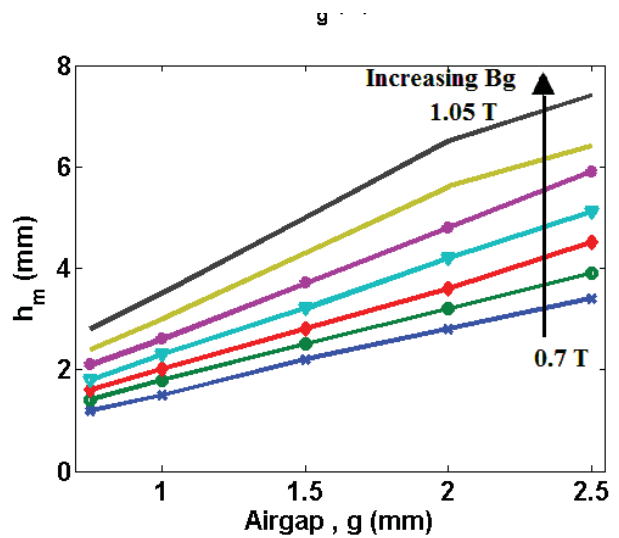

PM height versus air-gap size

Evaluated Machine

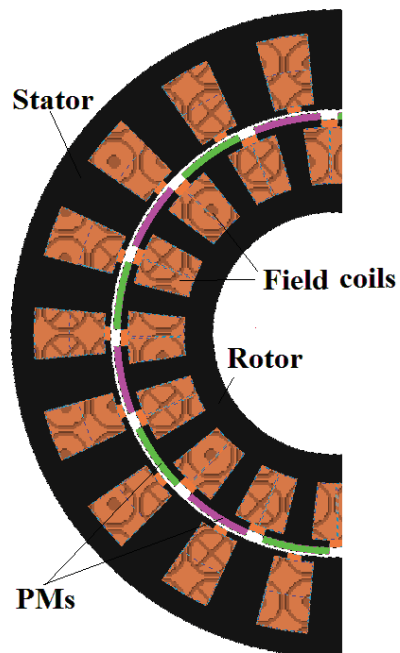

Design Specifications

Parameter	Value	Unit
Power	3	kW
Torque	76	Nm
Voltage	400	V
Frequency	50	Hz
Pole/slots	16/18	-
Air-gap diameter	300	mm
Stack length	60	mm
speed	375	rpm
Current density	6	A/mm^2

Evaluated Machine *cont...*

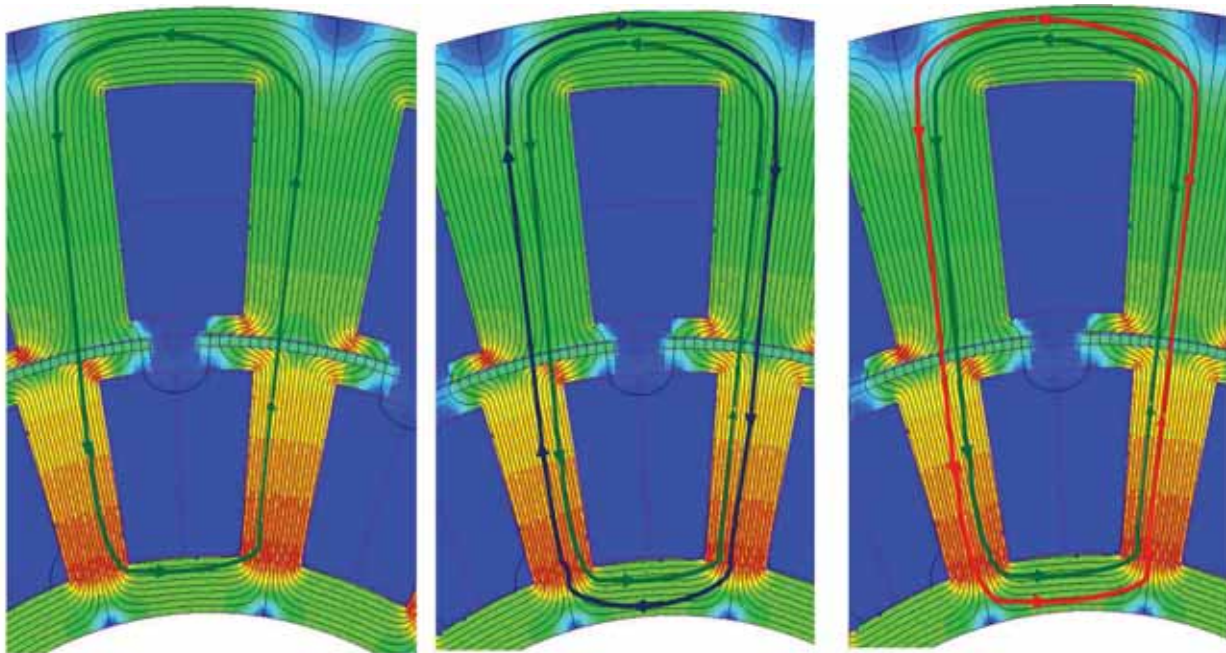

Normal flux

Flux weakening

Flux boosting

FEM Analysis

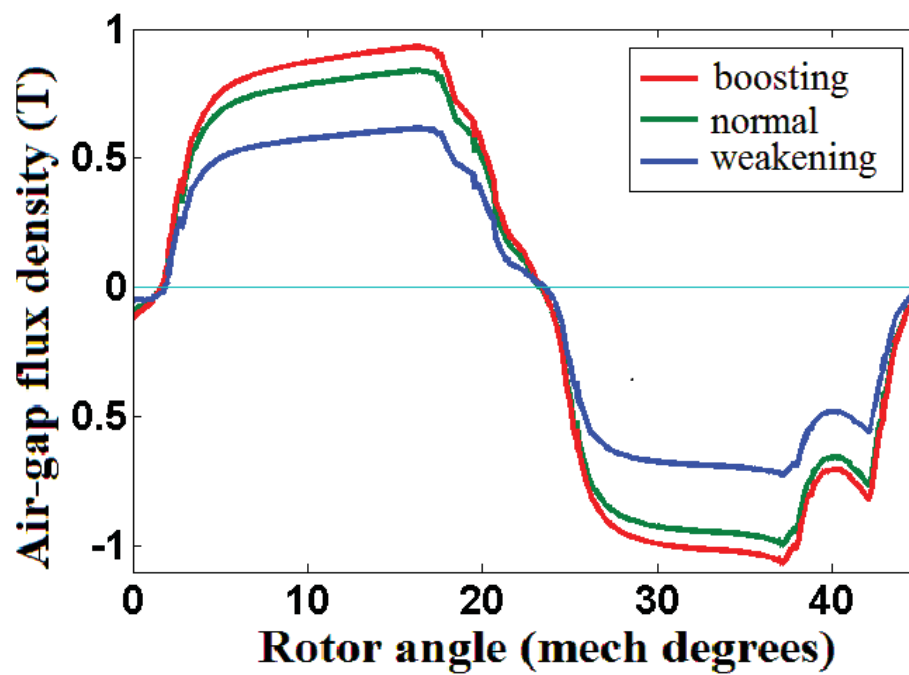

FEM Analysis *cont...*

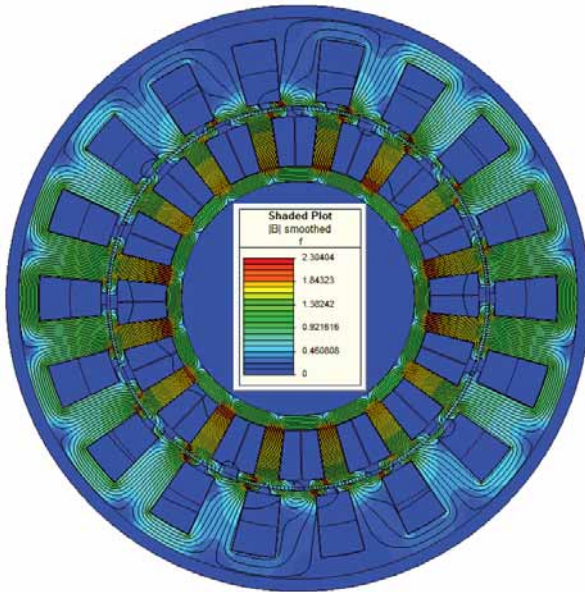

Normal

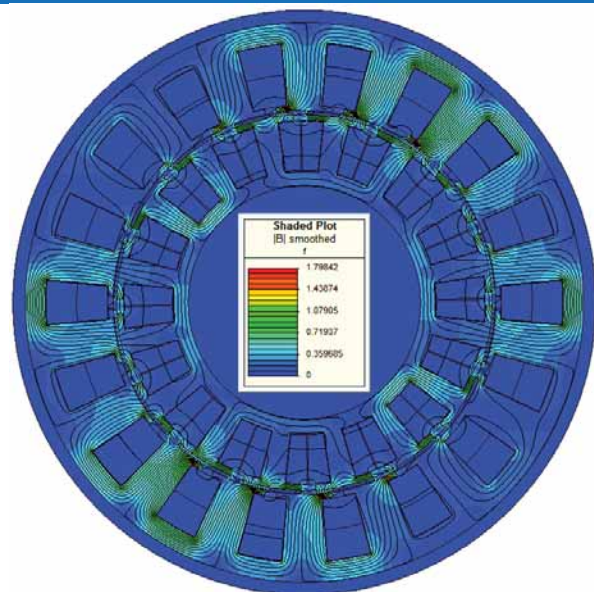

Weakening

FEM Analysis *cont...*

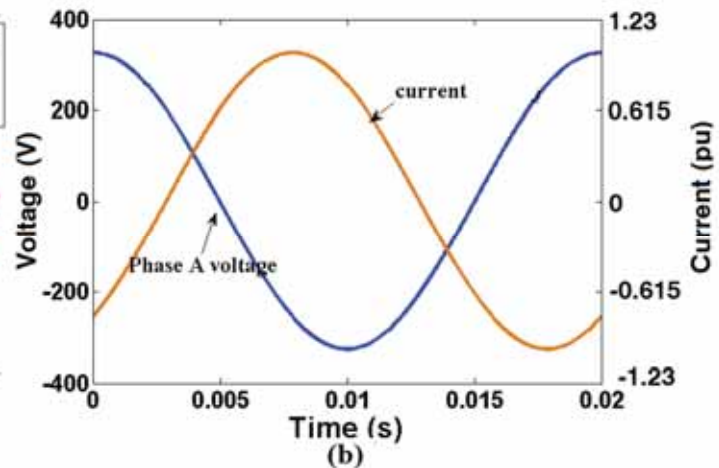
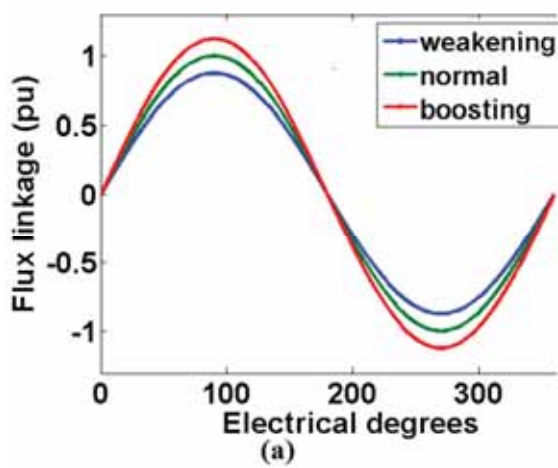

Flux linkage in the generator

Voltage and current relationship

Conclusion

- Combine advantages of PMSGs and conventional SGs.
- No need of power electronic converter.
- Operation at rated specifications even when there is rotor field windings failure.

